

EVO D ISOsafe DATA SHEET



5
YEAR
WARRANTY



Features

- * High strength spring installation, screwless terminal block
- * IP 54 rated, suitable for both indoor and outdoor applications
- * Suitable for 82~83 mm cutting out hole.s
- * 50,000 hours lifetime (L90F10). 5 year limited warranty.
- * Compatible with leading edge or trailing edge dimmers
- * Flicker free, CRI up to Ra98
- * 10 years anti-corrosion warranty
- * Complied with IEC/EN62471 photobiological safety standard



Operation and Maintenance Tips

- * Turn power off before inspection, installation or removal
- * Lamps should be kept free from contamination.
- * The luminaire is not suitable for emergency lighting
- * All install and uninstall shall be done by a certified electrician
- * Do not operate luminaire with damaged part
- * Exceeding maximum ratings for operating temperature and input voltage will reduce expected life time or destroy the product.

Energy Class

This product contains a light source in the energy efficiency class: F A1G

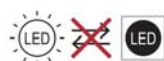

Electrical and Photometric Characteristics

LLED module power	7W
Input voltage of LED module	36VDC
IP rating	IP54
Nominal flux	650lm @ 3000K
CRI	Ra 98
Beam angle	60°
L90 Lifetime at Ta: 25°C	50,000 hrs
L80 Lifetime at Ta: 25°C	100,000 hrs
Switching cycles	> 100,000 times
Safety class of LED module	Class III
Energy class of LED module	F
Power with driver	9W
Nominal Voltage	220-240Vac 50/60Hz
Input current	45 mA
Inrush current	< 2A
Power Factor	0.9
Working temperature range	-20°C ...+40°C
Percent flicker	< 2%
PstLM	< 1
SVM	< 0.4
Dimmable	Yes
IP rating of driver	IP20

Specifications

EAN Code	Module Wattage*	Size mm (DxH)	CCT (Kelvin)*	Rated Flux (Lm) *	CRI (Ra)*	Beam angle*	Energy Class	SDCM	Anti-corrosion Warranty (year)
EVO D ISOsafe Hvid-for both indoor and outdoor use									
5703058002501	7	90x49	2700	630	98	60°	F	2	10
5703058002600	7	90x49	3000	650	98	60°	F	2	10
EVO D ISOsafe Sort-for both indoor and outdoor use									
5703058002709	7	90x49	2700	630	98	60°	F	2	10
5703058002808	7	90x49	3000	650	98	60°	F	2	10
EVO D ISOsafe Sunfall Hvid-for both indoor and outdoor use									
5703059001107	7	90x49	2500-3000	630	98	60°	F	3	10
EVO D ISOsafe Sunfall Sort-for both indoor and outdoor use									
5703059001206	7	90x49	2500-3000	630	98	60°	F	3	10

* Due to the special conditions of the manufacturing processes of LED, the typical data of technical parameters can only reflect statistical figures and do not necessarily correspond to the actual parameters of each single product which could differ from the typical value. A max 10% tolerance is deemed to be acceptable in any case.

* 25D and 38D version also available upon request.

Maximum loading of automatic circuit breakers

Breaker type	C10	C13	C16	C20	B10	B13	B16	B20	Inrush current	Inrush time
EVO D ISOsafe	120	160	200	240	60	80	100	120	Imax 2A	180µs

This are max. values calculated out of inrush current! Please consider not to exceed the maximum rated continuous current of the circuit breaker. Actual values may differ due to used circuit breaker types and installation environment.

Distribution of luminous intensity

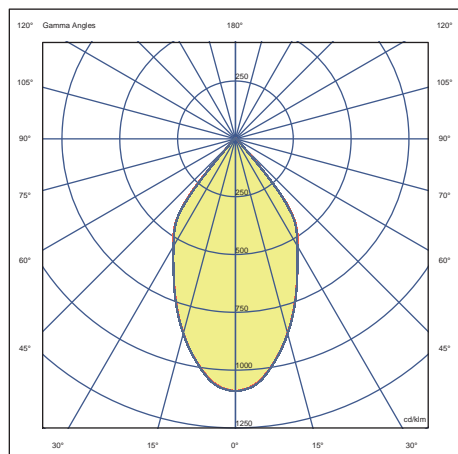

Dimension Diagram

Item	Outer Diameter (mm)	In-ceiling Height (mm)	Cut-hole (mm)
LED Module	90	46.5	55-64

Item	Length (mm)	Width (mm)	Height (mm)
Connector box	80	58	22
Driver box	60	47	22

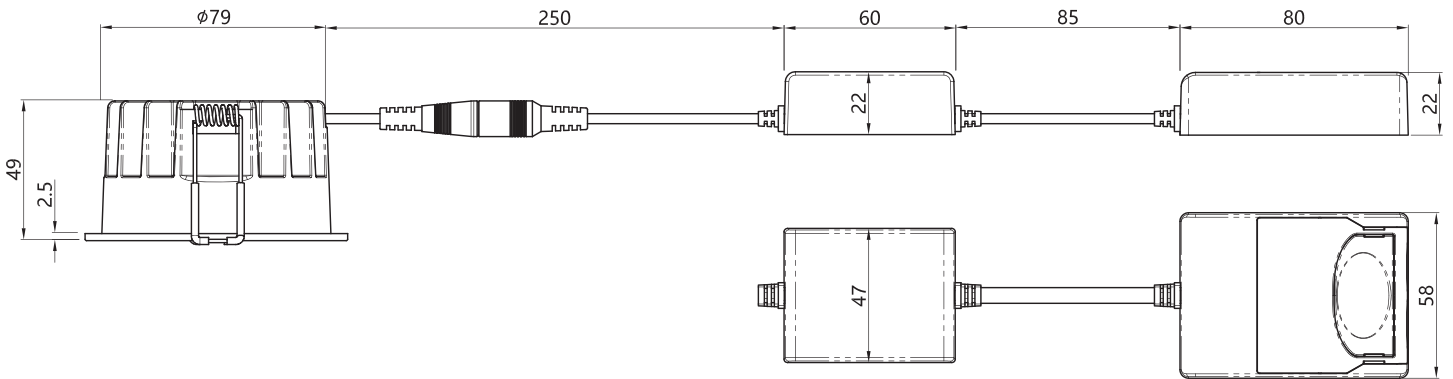

Spectrum Distribution

Warm white - 2700K

Warm white - 3000K

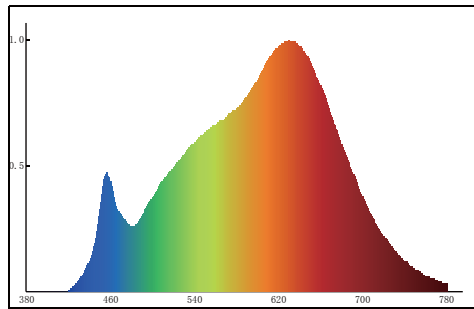
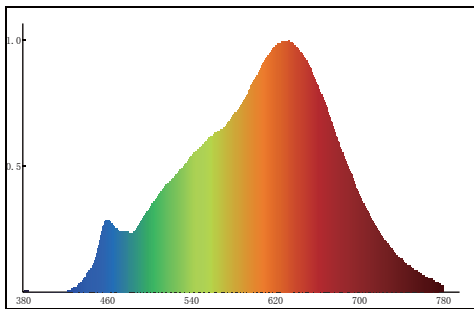

Lifetime

