

Reline med Tridonic DALI

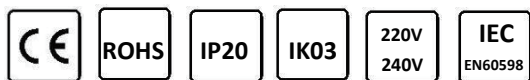
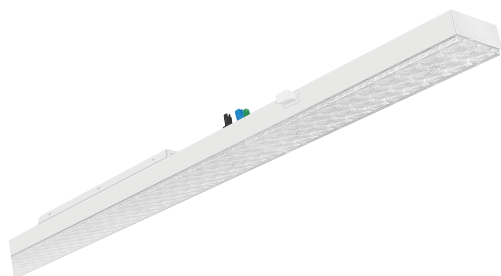

Product informaton

Reline med Tridonic DALI is an efficient, flexible and versatile system providing lighting solutions for various applications of industry, commerce, office, etc.

Features

- * Easy replacement of LED module and driver
- * Suitable for suspended, ceiling installation
- * 43S Easy and quickly installation
- * LED module efficiency >160lm/w
- * 30°, 60,90,120 PC/PMMA, Double-asymmetric 25°, Double-symmetric 15°

Product data

General Informadon	
Light source type	LED
Number of LED module	1 pcs
Beam angle of LED module	90°
Color temperature	4000K
CRI	80
LED module replaceable	Yes
Number of LED driver	1 unit
Driver included	Yes
L90 lifetime of LED module	26,000 hrs
L80 lifetime of LED module	54,000 hrs
LED module lumen	10108 lm
Operaring and Electrical	
Input Voltage	220-240 Vac
Input frequency	50 to 60 Hz
System wattage	67W
Inrush current	23A
Inrush time	174 μs
Power factor	0.92
Surge protection	2 kV(L/N-Ground)
Ambient temperature range	-20°C to +45°C
Performance ambient temperature Tq	+25°C
SDCM	3 steps
Optical type	Lens

Control and dimming	On/Off
Connection type	5 pole connector
Protection class IEC	Safety class I
Glow-wire test	Temperature 850°C
UGR	24
PstLM	<1
SVM	<0.4
CE Mark	Yes
EU RoHS compliant	Yes
Net weight (piece)	1.65Kg
Dimension	
Overall length	1438mm
Overall width	65mm
Overall height	55.2 mm
Mechanical and Housing	
Housing material	AL
Optical material	PMMA
Housing color	White
Heatsink material	AL
Ingress protection code	IP20
Meeh, impact protection code	IK03
Remarks	
LED driver failure rate at 50,000hrs@25°C	5%
Power consumption tolerance	±5%

Specifications

Varenummer	LED Module Wattage*	Length mm	Width mm	Height mm	CCT (Kelvin)*	Rated Flux (Lm) *	CRI (Ra)*	Beam angle*	Energy Class	Dimming technology
570105500200	67	1438	65	55.2	4000	10108	80	90°	D	DALI

* Due to the special conditions of the manufacturing processes of LED, the typical data of technical parameters can only reflect statistical figures and do not necessarily correspond to the actual parameters of each single product which could differ from the typical value. A max 10% tolerance is deemed to be acceptable in any case.

Dimension drawings

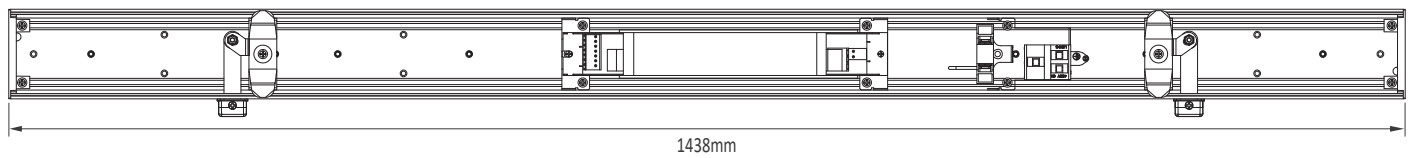
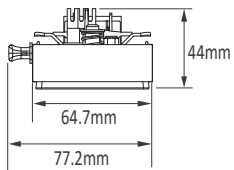

Installation manual

Option 1:

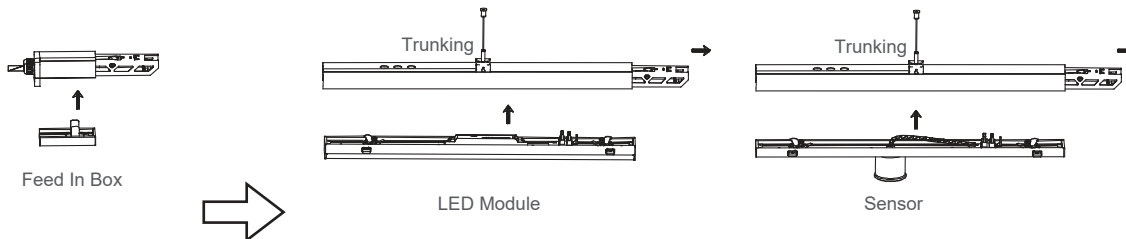

Option 2:

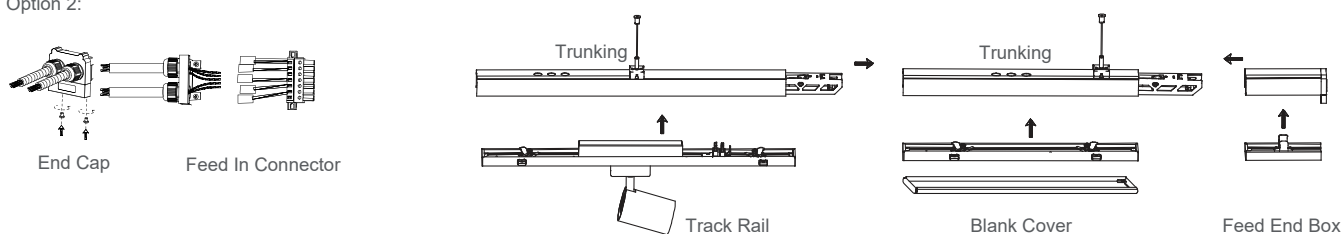

Installation Drawing

Step 1 Installation suspension

Chain suspension

Steel cable Suspension

Make a right position and screw hole on Ceiling

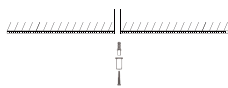
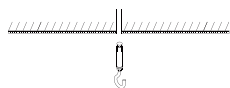

Fix mounting hook into ceiling

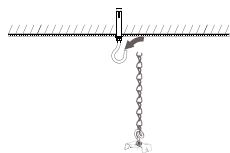

Click into the Trunking rails Then adjust the length of suspension kits

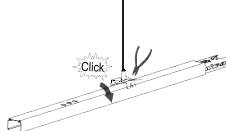
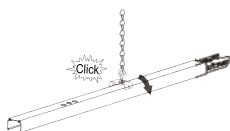
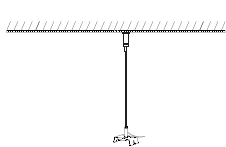
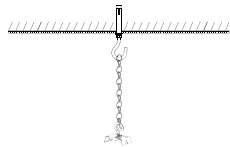

Step 2 Connecting Trunking

Both trunking rails keep in one line, then push

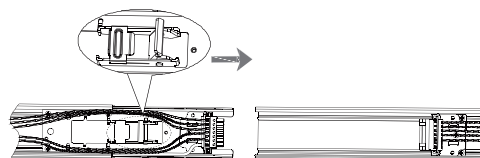

Press the Lock and Push the stator

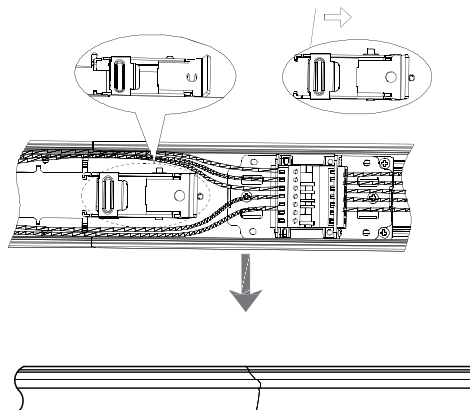

Step 3 Mounting LED module

Slide knob to select phase L1/L2/L3

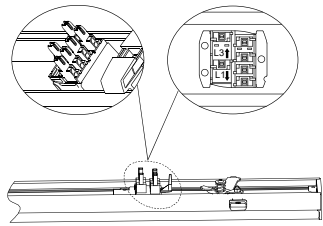

Pull the drawbar

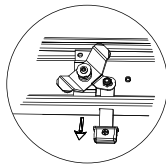

Make sure male & female connectors in right position then fix the led module to trunking

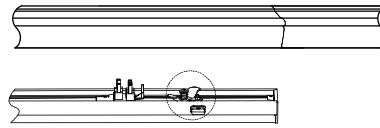

Pull the drawbar

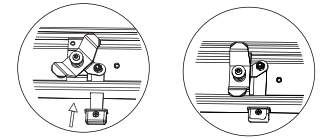

Step 4 Mounting accessory part

Mounting Sensor

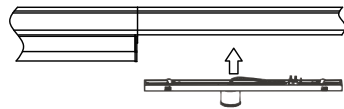

Mounting Track Rail

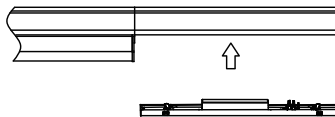

Mounting Blind cover



Step 5 Connecting power supply

Option 1: Use the Feed In BOX

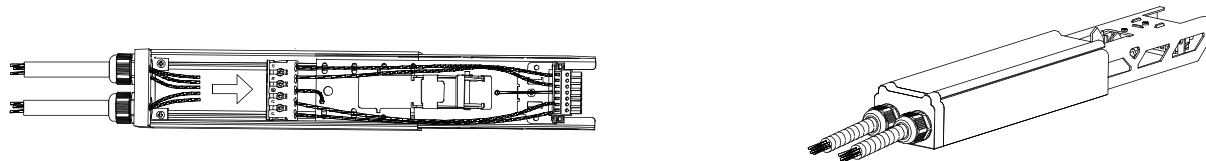

Option 2: Use the End Cap and Feed In Connector Screw

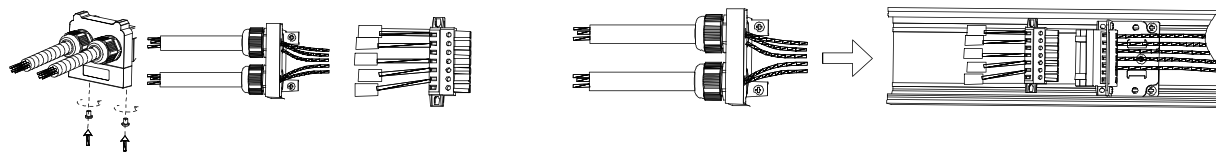

LED Linear Lighting System

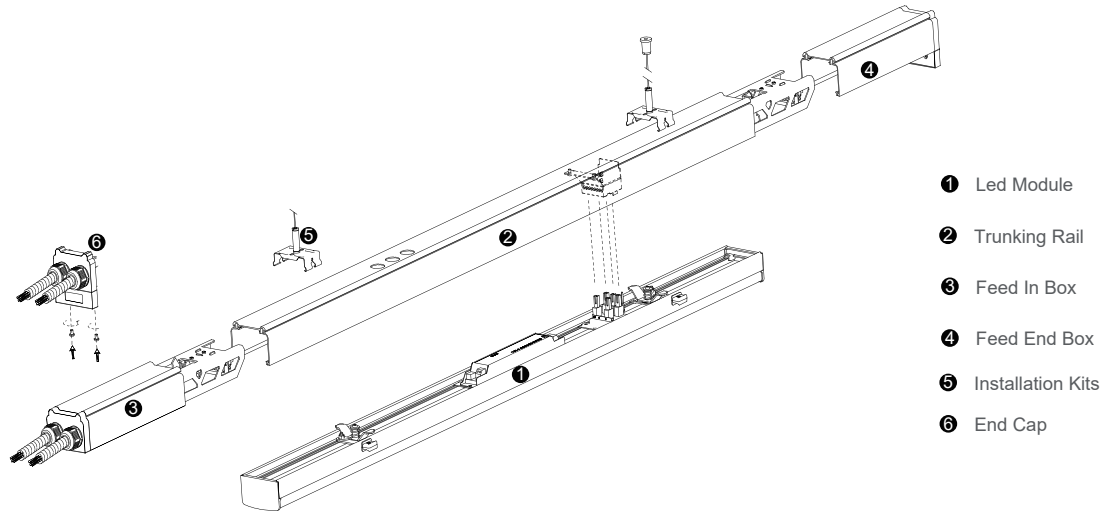

- ❶ Led Module
- ❷ Trunking Rail
- ❸ Feed In Box
- ❹ Feed End Box
- ❺ Installation Kits
- ❻ End Cap

Wire diagram

. 5 Wires

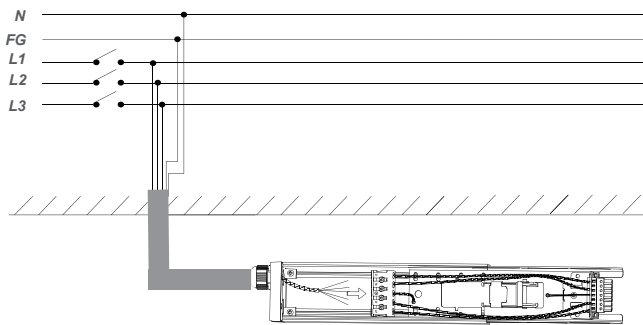

. 7 Wires

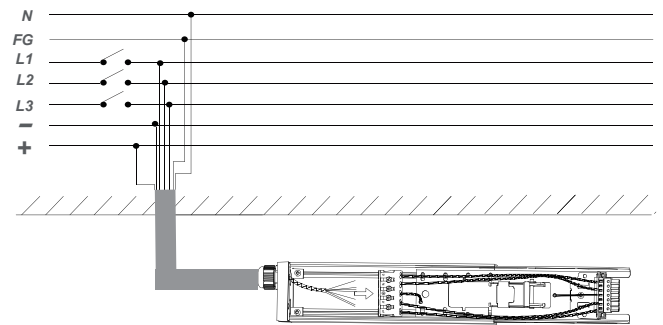

Accessory



Chain suspension Kits

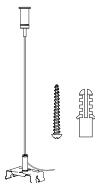

Steel cable Suspension Kits

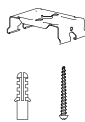

Ceiling Kits

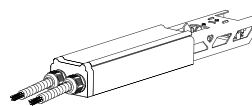

Feed In Box

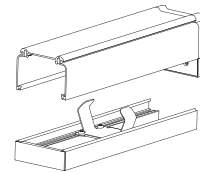

Feed End Box



PG13.5



End Cap

Safety notes:

The installation and connection of the luminaire must be done when power switched off and by qualified people.

Make sure no electrical power during installation .

Max current should not exceed 16A in one power feed in circuit.

UGR Table

Report number:

MANUFACTURER:										
Address:										
NAME:					TYPE:			WEIGHT:		
SPECIFICATION:					DIMENSION: 1438*65mm			SERIAL No.:		
ceiling/cavity	0.7	0.7	0.5	0.5	0.3	0.7	0.7	0.5	0.5	0.3
walls	0.5	0.3	0.5	0.3	0.3	0.5	0.3	0.5	0.3	0.3
working plane	0.2	0.2	0.2	0.2	0.2	0.2	0.2	0.2	0.2	0.2
Room dimensions	Viewed crosswise					Viewed endwise				
x = 2H y = 2H	22.5	23.9	22.8	24.1	24.3	22.8	24.1	23.1	24.3	24.6
3H	23.3	24.5	23.6	24.8	25.0	24.2	25.5	24.5	25.7	26.0
4H	23.7	24.8	24.0	25.1	25.4	24.8	25.9	25.1	26.2	26.5
6H	24.0	25.1	24.3	25.3	25.7	25.1	26.2	25.5	26.5	26.8
8H	24.1	25.1	24.4	25.4	25.8	25.4	26.4	25.7	26.7	27.0
12H	24.2	25.2	24.6	25.5	25.9	25.6	26.6	25.9	26.9	27.2
4H	2H	22.9	24.1	23.2	24.3	24.6	23.1	24.3	23.4	24.6
	3H	23.9	24.9	24.2	25.2	25.5	24.9	25.9	25.2	26.2
	4H	24.4	25.3	24.8	25.7	26.0	25.5	26.4	25.9	26.8
	6H	24.8	25.7	25.3	26.0	26.4	26.0	26.8	26.4	27.2
	8H	25.0	25.8	25.5	26.2	26.6	26.3	27.1	26.7	27.5
	12H	25.2	25.9	25.6	26.3	26.7	26.6	27.3	27.0	27.7
8H	4H	24.7	25.5	25.1	25.9	26.3	25.6	26.4	26.1	26.8
	6H	25.3	25.9	25.7	26.3	26.8	26.3	26.9	26.7	27.3
	8H	25.5	26.1	26.0	26.6	27.0	26.7	27.3	27.2	27.7
	12H	25.8	26.3	26.3	26.8	27.3	27.1	27.6	27.6	28.1
12H	4H	24.7	25.4	25.2	25.8	26.3	25.6	26.3	26.1	26.7
	6H	25.3	25.9	25.8	26.4	26.8	26.3	26.9	26.8	27.3
	8H	25.7	26.2	26.2	26.6	27.1	26.8	27.3	27.3	27.8
Variations with the observer position at spacings:										
S = 1.0H	+ 0.5 / - 0.6					+ 0.3 / - 0.4				
1.5H	+ 0.5 / - 0.5					+ 0.3 / - 0.3				
2.0H	+ 1.0 / - 0.6					+ 0.6 / - 0.5				

CIE Pub.117 Corrected 10108 lm Total Lamp Luminous Flux. (8log(F/F0) = 8.0)