

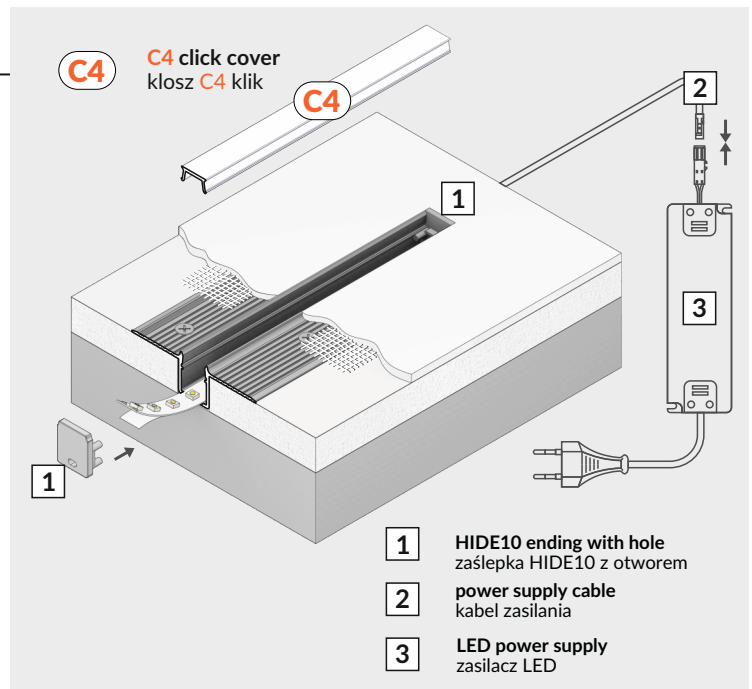

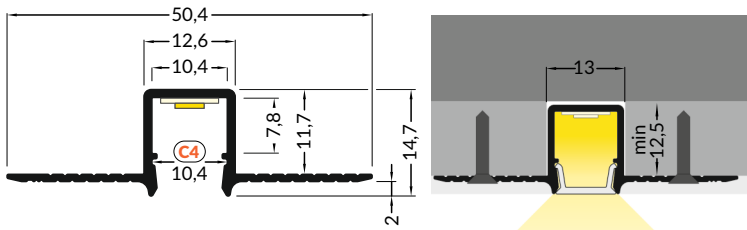





HIDE10 C4

RECESSED PROFILE / PROFIL WPUSTOWY

 max 10 mm



-  **scissors**
nożyczki
-  **hacksaw**
piłka
-  **pliers**
kombinerki
-  **solder**
cyna
-  **soldering iron**
lutownica
-  **screwdriver**
wkrętak
-  **drill**
wiertarka
-  **spatula**
szpachelka

I mounting space = length of the luminaire
otwór montażowy = długość oprawy

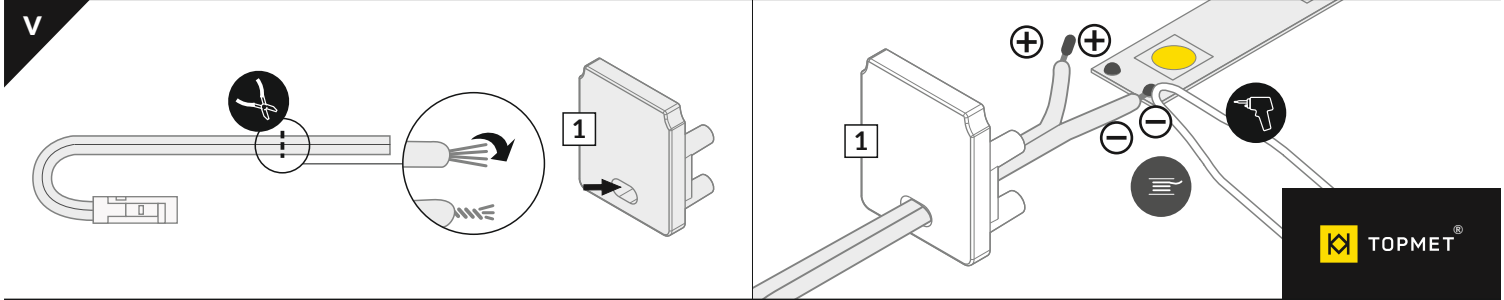
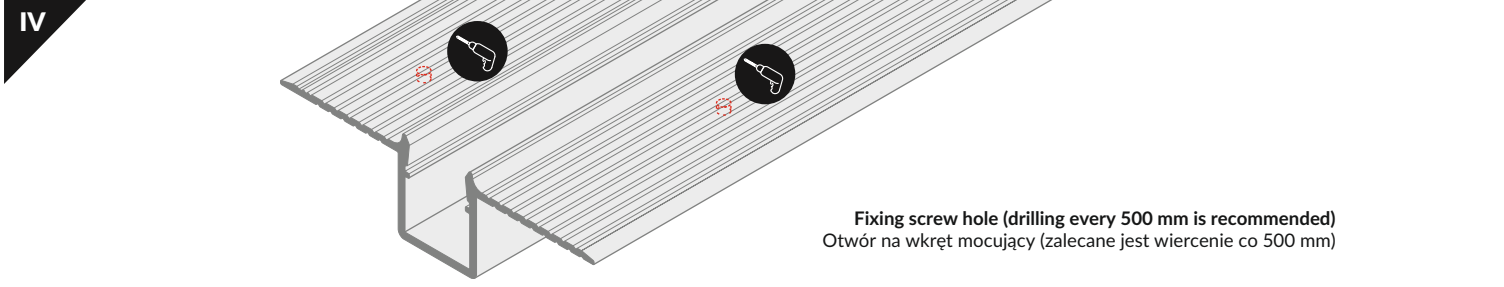
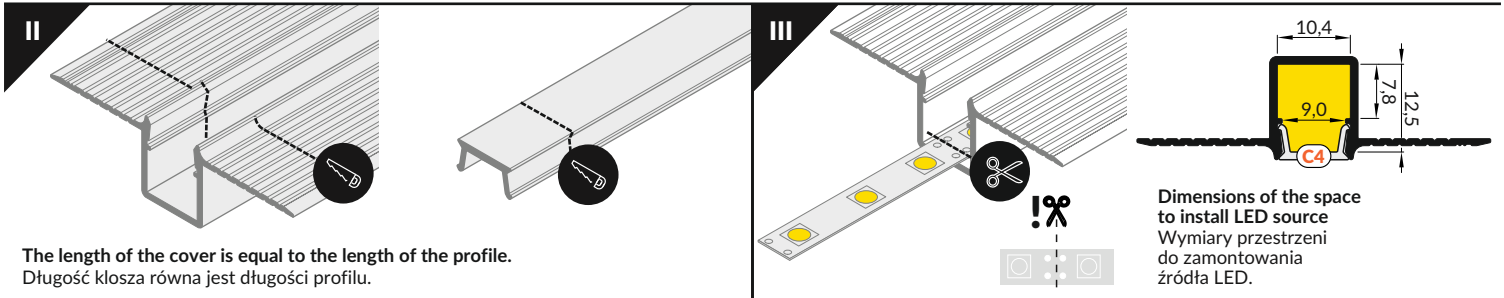
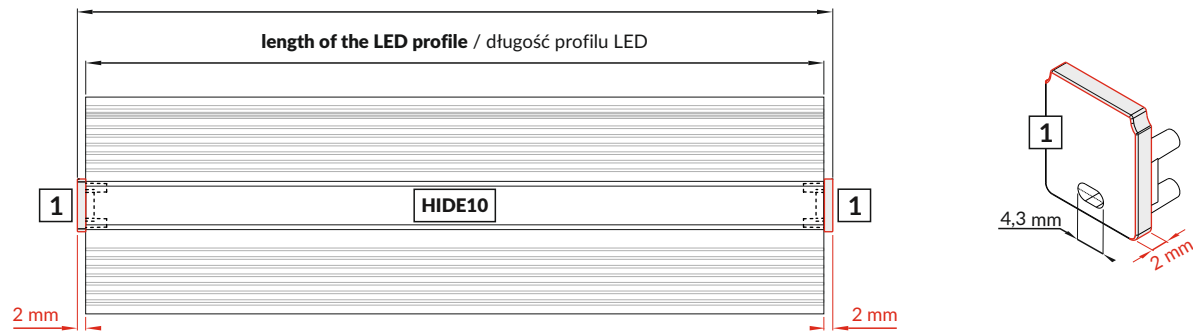

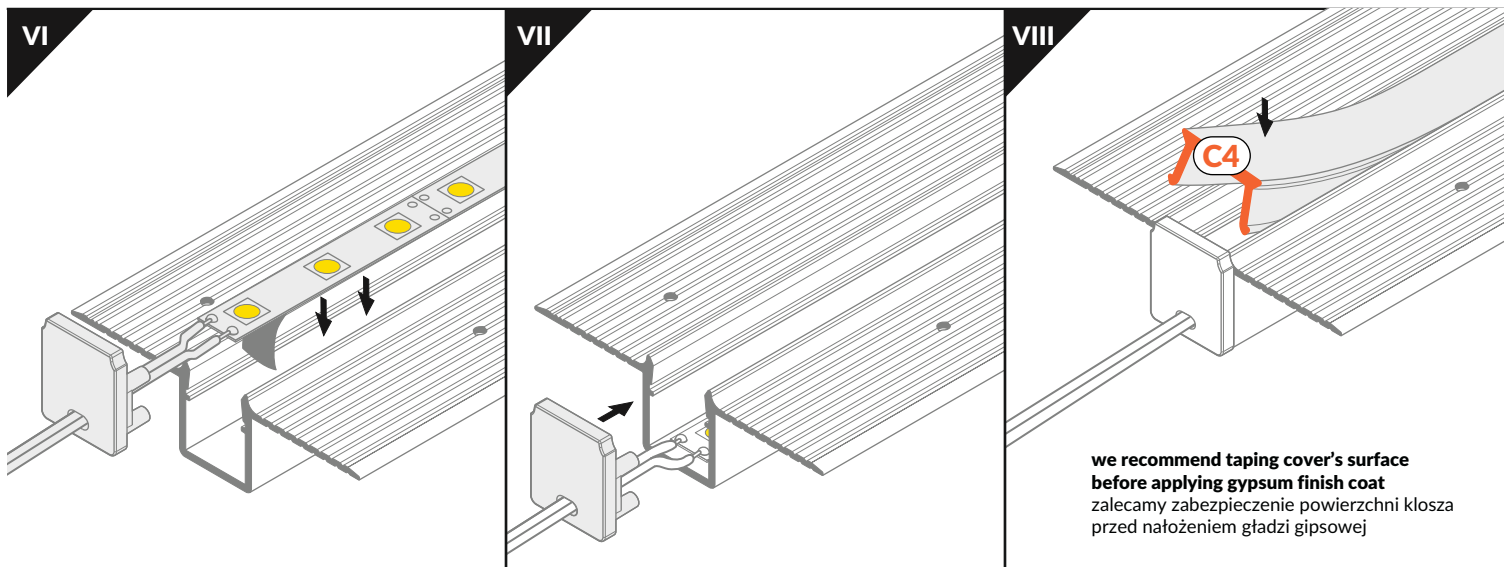

we recommend taping cover's surface before applying gypsum finish coat
 zalecamy zabezpieczenie powierzchni klosza przed nałożeniem gładzi gipsowej

IX MOUNTING / MONTAŻ

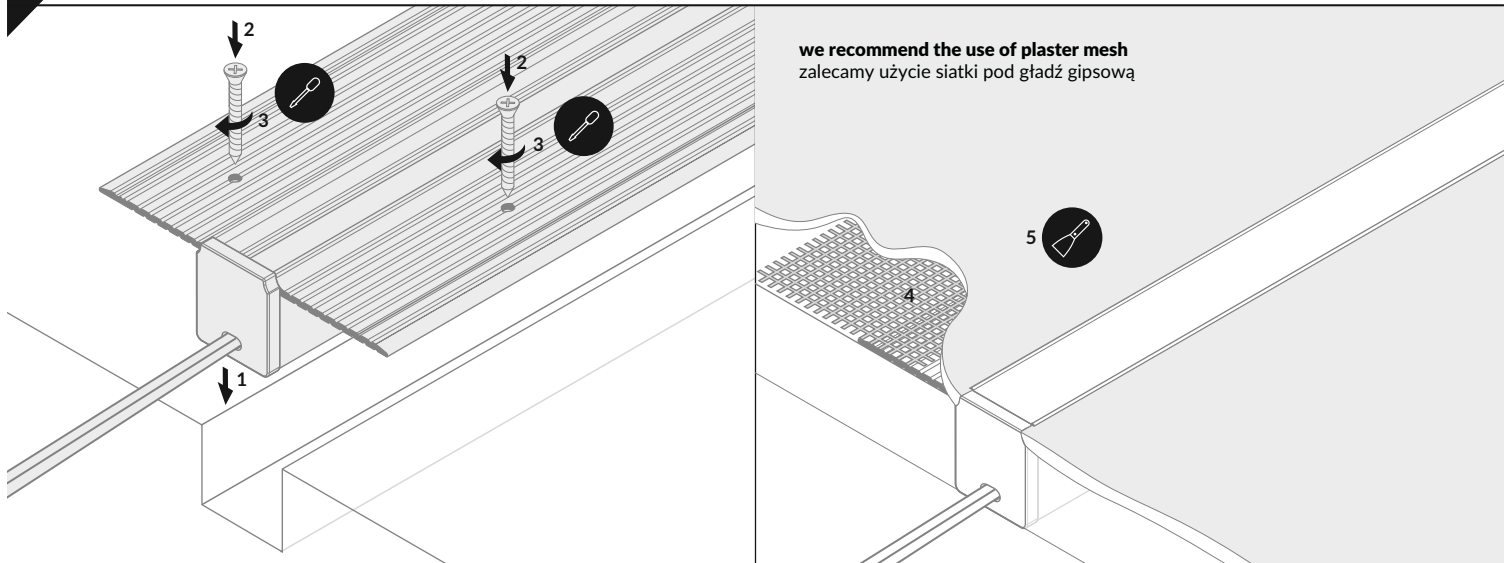

we recommend the use of plaster mesh
 zalecamy użycie siatki pod gładź gipsową

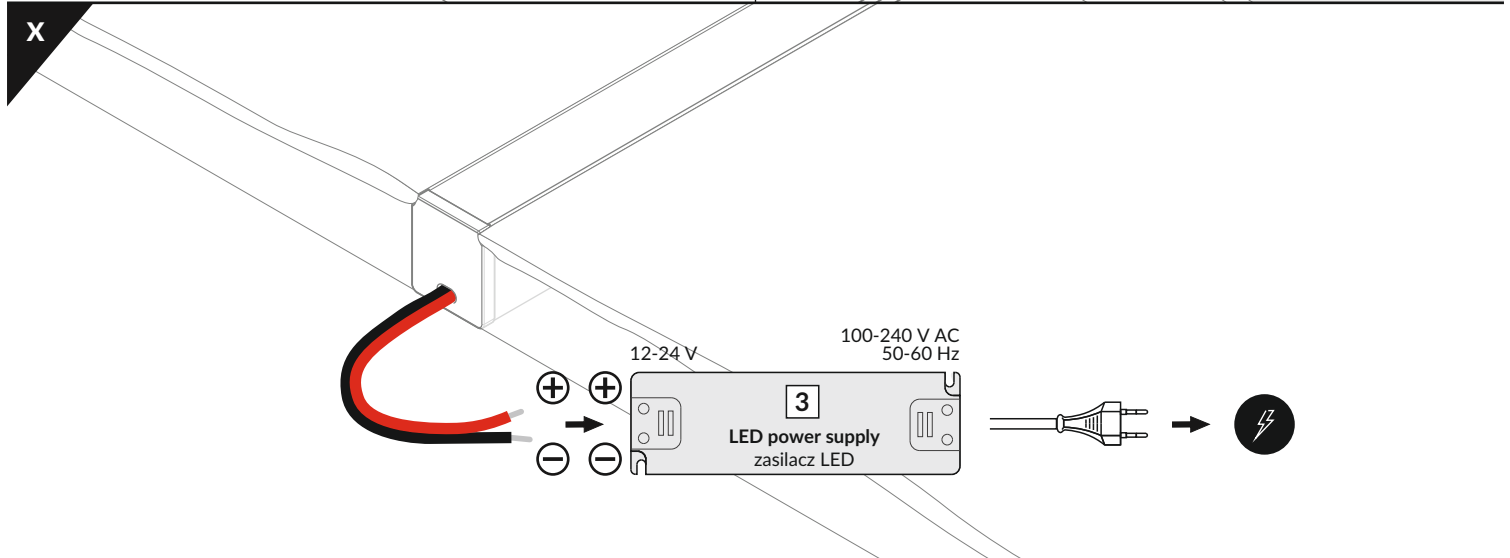

ACCESSORIES / AKCESORIA

power switches / włączniki
 controller + remote / sterownik + pilot
 movement sensors / czujniki ruchu